



INSTANT SCAFFOLDS

ERECTION GUIDE for 3m (10') SQUARE TOWERS

3m (10') SQUARE TOWERS

These mobile aluminium towers are most used where large work areas are required. The 3m square range provides free-standing work platforms up to 9m high and are quick and easy to move. They provide access for ceiling fixing, painting, sprinkler assembly and ducting installation.

SEE REVERSE SIDE FOR ERECTION DETAILS

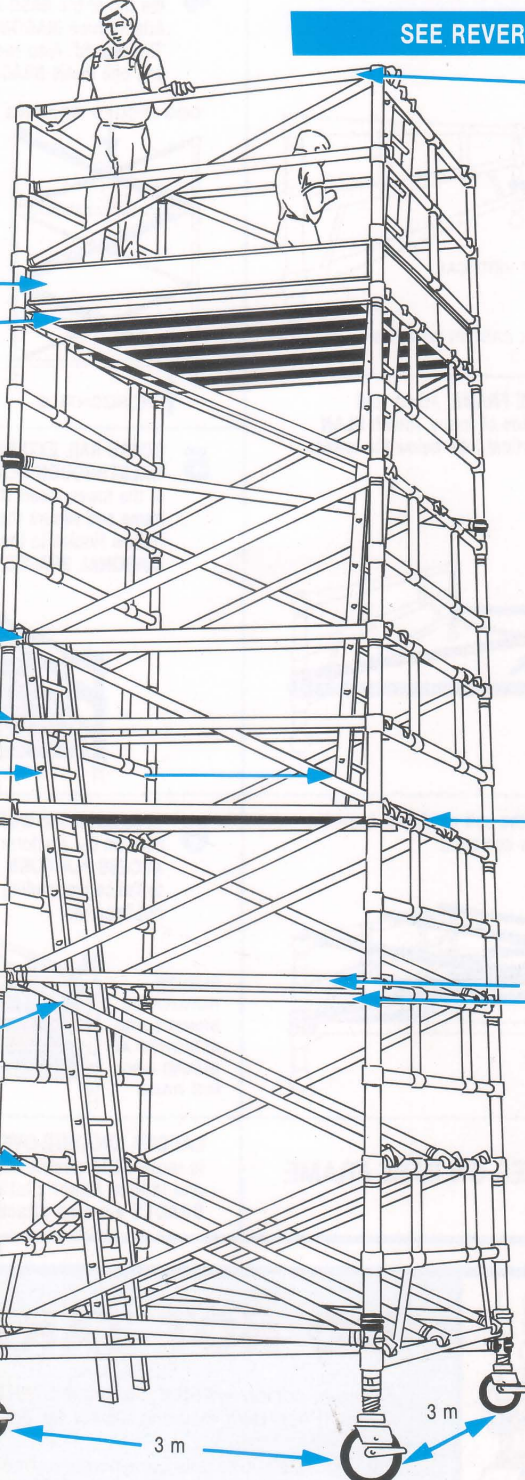

TOEBOARD
PLATFORMS

PLAN BRACE (Black Hooks)
Every 4th Extension Unit.

HORIZONTAL BRACE
(Yellow Hooks) (Use as hand rail
and mid-rail where required).

LADDERS

DIAGONAL BRACES

BASE FRAME
1.2m high (complete with
adjustable legs and castor
wheels).

PLAN BRACES
(Black Hooks)

SPECIFICATIONS	
Safe working load	: 2 men plus 25 Kg materials. Total 225 Kg
Width	: 3 m
Length	: 3 m
Frame Heights	
Base frame (with castors)	: 1.3 m to 1.5 m
Extension Frame	: 0.8 m (2 rungs)
Guard Rail Frame	: 1.1 m
Max. platform height	: 9.0 m free standing
Max. working height	: 10.8 m

200mm CASTOR WHEEL
and
ADJUSTABLE LEG

HORIZONTAL BRACE
(Yellow Hooks) (Use as hand rail
and mid-rail where required).

GUARD RAIL EXTENSION
= 2 FRAMES
2 HORIZONTAL BRACES
2 DIAGONAL BRACES

1 WALK-THROUGH PLATFORM
4 PLAIN PLATFORMS
1 TOEBOARD (OR MID-RAILS)
1 LADDER

0.8 m EXTENSION UNIT
= 2 MANWAY FRAMES
3 DIAGONAL BRACES

LADDER CHANGE-OVER
PLATFORM (WALK-THROUGH)

2 HORIZONTAL BRACES EVERY
4th RUNG (1.6m)

BASE UNIT
= 2 MANWAY BASE FRAMES
(adjustable legs and castor
wheels)
6 DIAGONAL BRACES
2 HORIZONTAL BRACES
PLAN BRACES

NOTE: The tower illustrated may be used higher than stated if tied-in to a stable structure in an approved manner.

Specifications vary in different States. To ensure departmental and health and safety compliance please check with your local Instant Scaffolds representative. Licenced Scaffolders must be used to erect towers above a stated height. This height varies from state to state. Please check your local regulations if in doubt.

for **INSTANT SERVICE**

TEL: 08 94519400
FAX: 08 94519444
Email: iswa@instantscaffolds.com.au
Web: www.instantscaffolds.com.au

12 BELLOWS ST
WELSHPOOL
WEST AUSTRALIA 6106



INSTANT SCAFFOLDS

ERECTION GUIDE

3m (10') SQUARE TOWERS

- 1** Attach **HORIZONTAL BRACE** (yellow hooks) to vertical tube of **BASE FRAME**. Ensure castors are locked. Frame is now self-supporting.

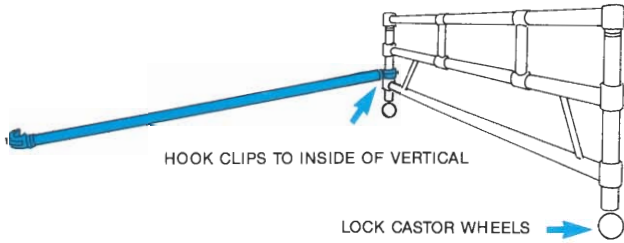

- 2** Attach spare end of brace to end of other **BASE FRAME**. Attach 2nd **HORIZONTAL BRACE(S)** (black hooks) diagonally onto the vertical tube below the lowest base frame rung, or as low down as possible.

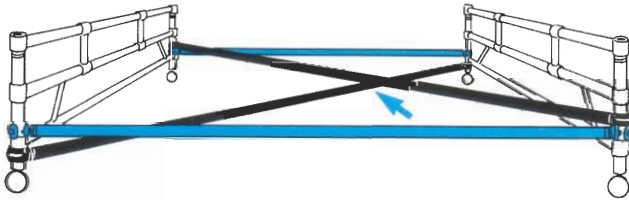

- 3** Attach six **DIAGONAL BRACES** to the base of the unit as shown. Level the unit using the adjustable legs. The base is now complete.

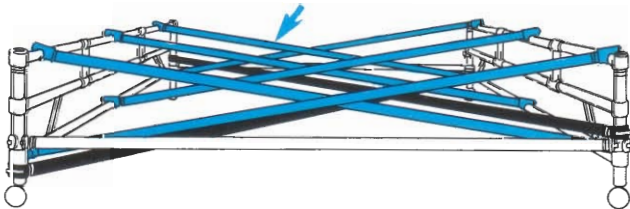

BEFORE USE, PLEASE READ RULES ON BASE FRAME

- 4** Additional 0.8m extensions. Insert an **EXTENSION FRAME**, spigots first, into the top of the **BASE UNIT** and secure interlock clips, see drawing below. Attach three **DIAGONALS** to frame as shown. Diagonal bracing must be 'Dog-legged'. Also two **HORIZONTALS** must be attached every 2nd extension, and one **PLAN BRACE** every 3.2m (or every 4th extension).

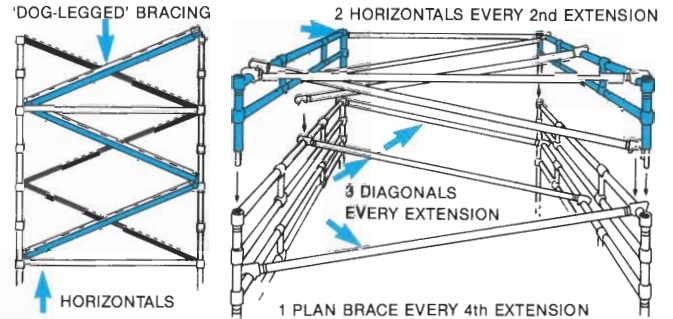

- 5** **GUARD RAIL EXTENSION:** Fit the four **PLAIN PLATFORMS** first, then the **WALK-THROUGH PLATFORM** with the hinges of the trap-door to the outside of the tower. Insert the **GUARD RAILS**, spigots first, into the top of the last frame and secure the interlock clips. Attach two **HORIZONTAL BRACES** (Yellow Hooks) to the top rung of the **GUARD RAIL FRAME** and two **DIAGONAL BRACES**, for rigidity, as shown.

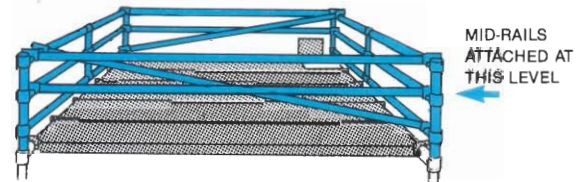

- 6** To complete the **WORK PLATFORM**, first fit the **TOEBOARD** to allow the trap-door on the platform to open freely. Finally attach the **LADDER** through the **ACCESS PLATFORM**, as shown, and clip on stand-off hooks, at base of ladder, to the corresponding rung on the frame. Ensure the access door movement is not impaired.

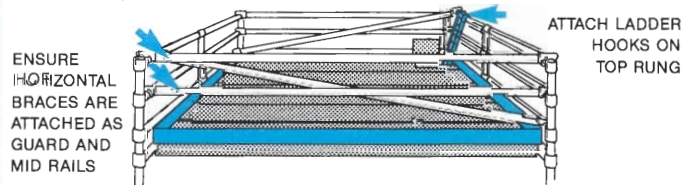

LADDER 'CHANGE-OVER' PLATFORMS: One **WALK-THROUGH PLATFORM** is required to enable safe ladder change-over on towers with more than one ladder. Attach platform before ladder. Ensure two **HORIZONTAL BRACES** are also attached as **GUARD RAILS** and **MID RAILS**.

LEG ADJUSTMENT

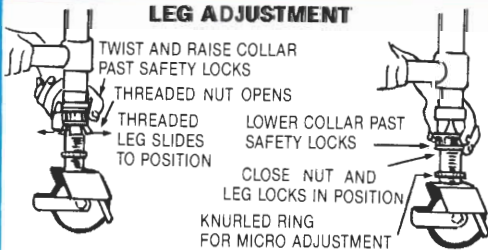

DO NOT TAKE CHANCES!

Failure to comply with the relevant INSTANT SCAFFOLDS Erection Guide may result in the Owner/Hirer/User incurring liability for damage and accident claims.

For your safety, use only genuine guaranteed INSTANT SCAFFOLDS components. Substituting other manufacturers' components could be dangerous and is not recommended.

FRAME LOCK

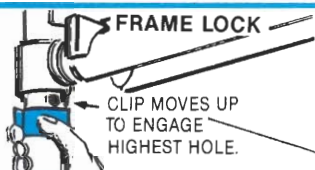

If in doubt, phone your nearest **INSTANT** branch for advice — YOUR SAFETY MAY DEPEND ON IT!

BRAKE LEVER

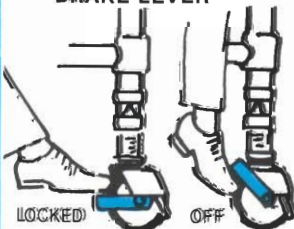

NO-CLOG SNAP-ON HOOKS

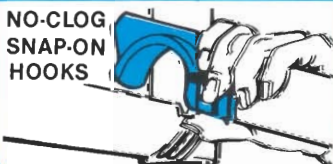

LIFETIME GUARANTEE

"RIB-GRIP" joints are so superior to the old fashioned welded method that INSTANT SCAFFOLDS guarantees to exchange any fitting or component that is in any way defective in a "RIB-GRIPPED" joint, for the life of the equipment.